



2294 Old Highway 431 • Owens Cross Roads, AL 35763
 Ph: (256)725-2500 or (877)725-8272 • Fax: (877)333-8272
 WWW.TARALINERS.COM

SPECIAL TRUE-L RIGHT ORDER FORM

Date: _____ Due: _____

FROM

Company: _____

Address: _____

CITY STATE ZIP

Phone: (____) _____

Ordered By: _____

SHIPPING INSTRUCTIONS

Ship To: _____

Address: _____

CITY STATE ZIP

Ship Via: _____

Other: _____

ORDER INFORMATION

PO #: _____

Job Name: _____

Price: _____

Serial #: _____

Stock #: _____

Sidewall Pattern: _____

Bottom Pattern: _____

MOUNTING

Beaded: Overlap: Overlap Size: _____ INCHES

COMMENTS

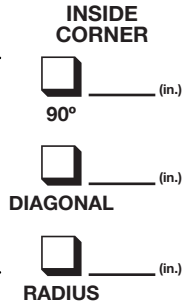
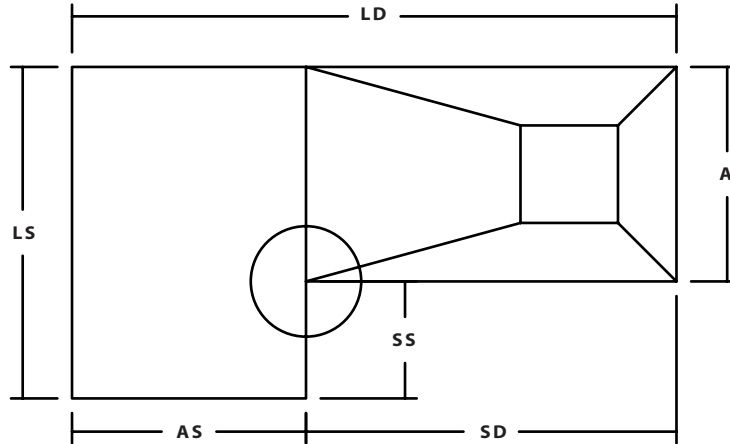

CORNER TYPE

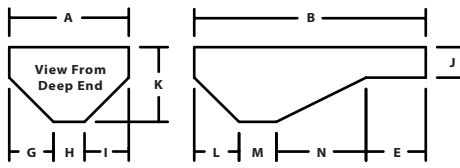
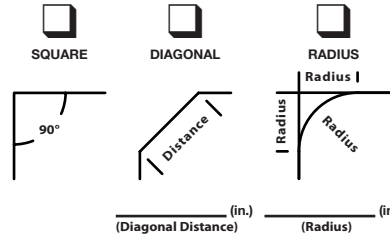

POOL MANUFACTURER, IF KNOWN:

SAFETY LEDGE



COVE

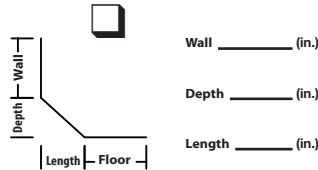

STEP DETAILS

INDICATE POSITION OF VINYL STEP IF APPLICABLE

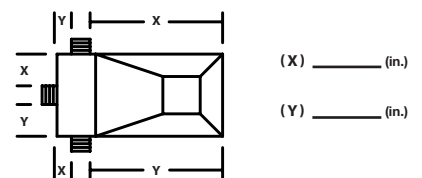

MEASUREMENTS

(A): _____ (ft.) _____ (in.) (L): _____ (ft.) _____ (in.)

(B): _____ (ft.) _____ (in.) (M): _____ (ft.) _____ (in.)

(E): _____ (ft.) _____ (in.) (N): _____ (ft.) _____ (in.)

(G): _____ (ft.) _____ (in.) (AS): _____ (ft.) _____ (in.)

(H): _____ (ft.) _____ (in.) (LD): _____ (ft.) _____ (in.)

(I): _____ (ft.) _____ (in.) (LS): _____ (ft.) _____ (in.)

(J): _____ (ft.) _____ (in.) (SD): _____ (ft.) _____ (in.)

(K): _____ (ft.) _____ (in.) (SS): _____ (ft.) _____ (in.)

Self Check

G+H+I=A?
 E+L+M+N=B?
 STEP RISERS=B?

VINYL STEP

Set Back

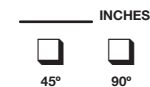

Step Corners



ROD POCKETS

YES NO

